

# TRETIGHT™

## TRETIGHT 800 & TRETIGHT LIGHT 800

Inflatable dock seals with outstanding sealing ability

NEW  
material

## PROTECTS GOODS AND ENVIRONMENT DURING LOADING AND UNLOADING

If an industry building is not equipped with a proper dock sealing solution, the loss of refrigerated, cooled or heated air leads to unnecessarily high energy bills. Insufficient protection against dirt, dust and insects causes inferior goods quality. The TRETIGHT™ portfolio offers dock seals which effectively keep out cold, rain, wind and contaminants when unloading and loading goods.

### FEATURES & BENEFITS

- **Versatile** - Fits a majority of loading bays and vehicles
- **Environmentally friendly**: Saves energy by preventing air flow between different temperature areas
- **Improves the work environment**: Preserves internal temperatures and does not add any extra noise
- **Extremely durable** - There are units on the market that have been in use for 15+ years
- **Weatherproof** - The seal is not affected by the weather - the material remains elastic and supple even in cold conditions
- **User friendly**: Simple installation & minimum maintenance
- **Easy to operate**: Inflates by pushing a single button
- **Customizable**: The different cushions can be combined and adapted to fit various sizes of doors



### APPLICATIONS

- Cold storage facilities
- Food & Beverage industry
- Logistic & Distribution centres
- Warehouses

# TRETIGHT™

## TRETIGHT 800 & TRETIGHT LIGHT 800

Inflatable dock seals with outstanding sealing ability

### MATERIAL



- TRETIGHT™ and TRETIGHT™ LIGHT are made of unique chloroprene rubber coated polyamide fabrics.
- Both materials are strong, very durable and offer an outstanding resistance against wear and tear.
- The flexibility of the material in combination with low pressure, preserves internal temperatures and protects products from outside contaminants
- The material properties allow for easy repair in case a cushion is damaged.

### CONSTRUCTION

- The TRETIGHT™ system consists of four main components - the top cushion, two side cushions and the fitting set.
- The fitting items are made of steel and aluminium, and are easily assembled. All parts are delivered as a complete ready-to-install set
- For inflation, the system uses a fan (part of the fitting items), which is specially selected to ensure an optimal seal to the docked vehicle. Three-phase and single-phase options are available.



### MATERIAL PROPERTIES

PROPERTY	TRETIGHT™ LIGHT - NEW MATERIAL	TRETIGHT™
Fabric	Polyamide	
Coating	Chloroprene rubber	
Weight	410 ± 25 g/m <sup>2</sup>	
Colour		
Tensile strength (ISO 1421)	> 1400 N/50 mm	> 1600 N/50 mm
Tear strength (ISO 4674)	> 180 N	> 200 N
Abrasion resistance (ISO 5470-1)	> 1000 rotations to rubber breakthrough	> 1000 rotations to rubber breakthrough
Material is resistant to low temperatures (SS-ISO 812)		

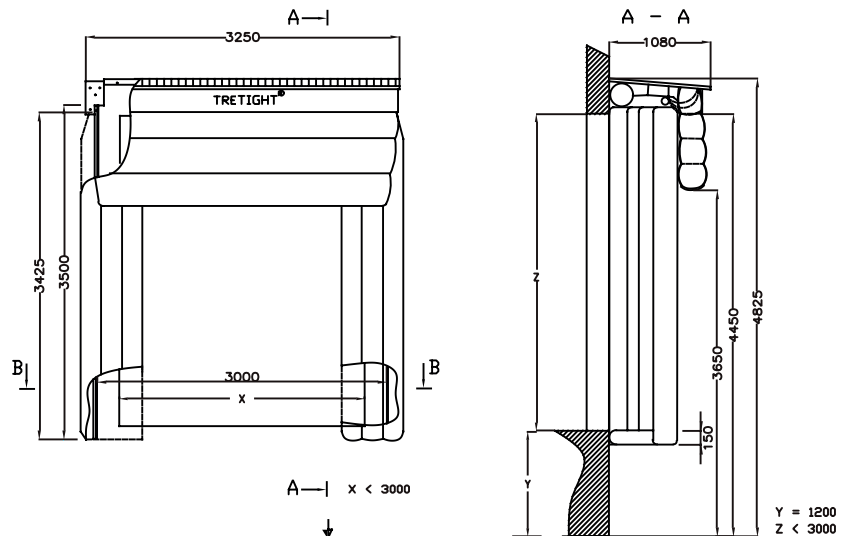

### TOP CUSHION MEASUREMENTS (mm)

TOP	NUMBER OF DUCTS	EXTENSION LENGTH	WIDTH OF CUSHION
800	4	800	3200

### SIDE CUSHION MEASUREMENTS (mm)

SIDE	NUMBER OF DUCTS	LENGTH OF CUSHION	EXTENSION LENGTH
700	4	3500	700
1000	5	3650	1000

**Ansell Protective Solutions AB**  
 Johan Kocksgatan 10  
 231 81 Trelleborg, Sweden  
 Tel: +46 (0)10 205 1800  
 Fax: +46 (0)10 205 1840  
 order.protective@ansell.com  
 http://protective.ansell.com

® & ™ are trademarks owned by Ansell Limited or one of its affiliates. © 2017 Ansell Limited. All Rights Reserved.

